

General Specifications

Electrical Capacity (Resistive Load)

Power Level (silver): 3A @ 125V AC or 3A @ 250V AC or 3A @ 30V DC
Logic Level (gold): 0.4VA maximum @ 28V AC/DC maximum
 (Applicable Range 0.1mA ~ 0.1A @ 20mV ~ 28V)
 Note: Find additional explanation of operating range in Supplement section.

Other Ratings

Contact Resistance: 50 milliohms maximum for silver; 100 milliohms maximum for gold
Insulation Resistance: 200 megohms minimum @ 500V DC
Dielectric Strength: 1,000V AC minimum between contacts for 1 minute minimum;
 1,500V AC minimum between contacts & case for 1 minute minimum
Mechanical Life: 1,000,000 operations minimum for momentary circuit
 200,000 operations minimum for maintained circuit
Electrical Life: 100,000 operations minimum
Nominal Operating Force: Single pole: 1.47N for nonsealed; 1.67N for sealed
 Double pole: 2.75N for nonsealed; 2.94N for sealed
Contact Timing: Nonshorting (break-before-make)
Travel: Pretravel .059" (1.5mm); Overtravel .059" (1.5mm); Total Travel .118" (3.0mm)

Materials & Finishes

Housing/Bezel: Glass fiber reinforced polyamide (UL94V-0)
Snap-in Frame: Stainless steel
Base: Glass fiber reinforced polyamide (UL94V-0)
Movable Contactor: Phosphor bronze with silver or gold plating
Movable Contacts: Silver alloy with silver plating or brass with gold plating
Stationary Contacts: Silver alloy or copper with gold plating
Switch Terminals: Phosphor bronze with tin plating
Lamp Terminals: Phosphor bronze with tin plating

Environmental Data

Operating Temperature Range: -25°C through +50°C (-13°F through +122°F) for Illuminated
 -25°C through +70°C (-13°F through +158°F) for Nonilluminated
Humidity: 90 ~ 95% humidity for 96 hours @ 40°C (104°F)
Vibration: 10 ~ 55Hz with peak-to-peak amplitude of 1.5mm traversing the frequency range & returning in 1 minute; 3 right angled directions for 2 hours
Shock: 50G (490m/s²) acceleration (tested in 6 right angled directions, with 5 shocks in each direction)
Sealing: IP65 of IEC60529 standard for panel seal models

Installation

Mounting Torque: 0.785Nm (6.95 lb•in) maximum
Quick Connect Force: 24.5N maximum downward force on connector
Soldering Time & Temperature: Manual Soldering: See Profile A in Supplement section.

Standards & Certifications

Flammability Standards: UL94V-0 housing & base
UL: **File No. E44145 - Recognized only when ordered with marking on switch.**
 Add "/U" or "/CUL" before first dash in part number to order UL recognized switch.
 All solder lug models recognized at 3A @ 125/250V AC or 0.4VA @ 28V AC/DC maximum.
CSA: **File No. 023535_0_000 - Certified only when ordered with marking on switch.**
 Add "/C" before first dash in part number to order CSA certified switch.
 All solder lug models certified at 3A @ 125/250V AC or 0.4VA @ 28V AC/DC maximum.

Distinctive Characteristics

Full face or spot illumination with incandescent lamps or multi-element LEDs, with or without resistors.

Choice of super bright LEDs in white, green, and blue as well as bright LEDs in red, amber, and green.

Combination bezel-barrier is an integral part of the switch and prevents accidental actuation.

Unique thermoplastic elastomer seal inside caps plus rolled sleeve of nitrile butadiene rubber at joining of housing and inner case, all for added protection to interior mechanism.

Dust and oil tight as well as splashproof panel seal models qualify to IP65 of IEC60529 Standards (similar to NEMA 4 and 13). Panel seal models provided with exterior o-ring.

Distinctive design of snap-action contacts for shock resistance, long life, and sensitive actuation.

High density design to give behind panel depth of less than one inch.

Terminals are epoxy sealed to lock out flux, dust, solvents, and other contaminants.

Latchdown for indication of circuit status, plus audible, tactile feedback with smooth, responsive operation.

Matching indicators available.

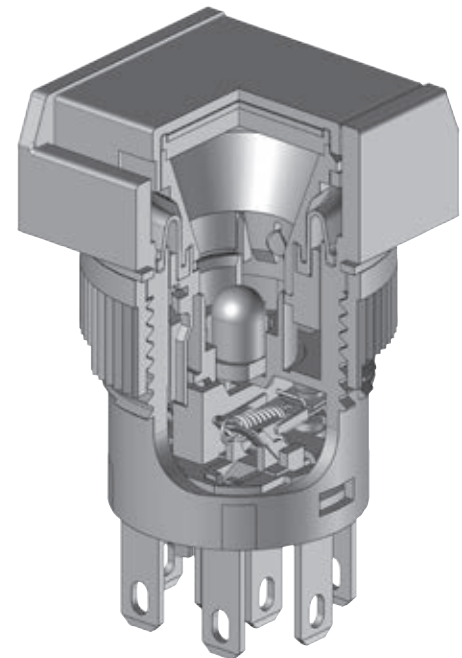

Actual Size

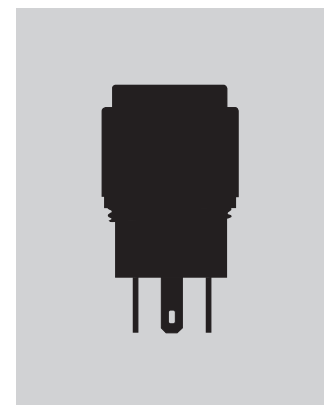

TYPICAL SWITCH

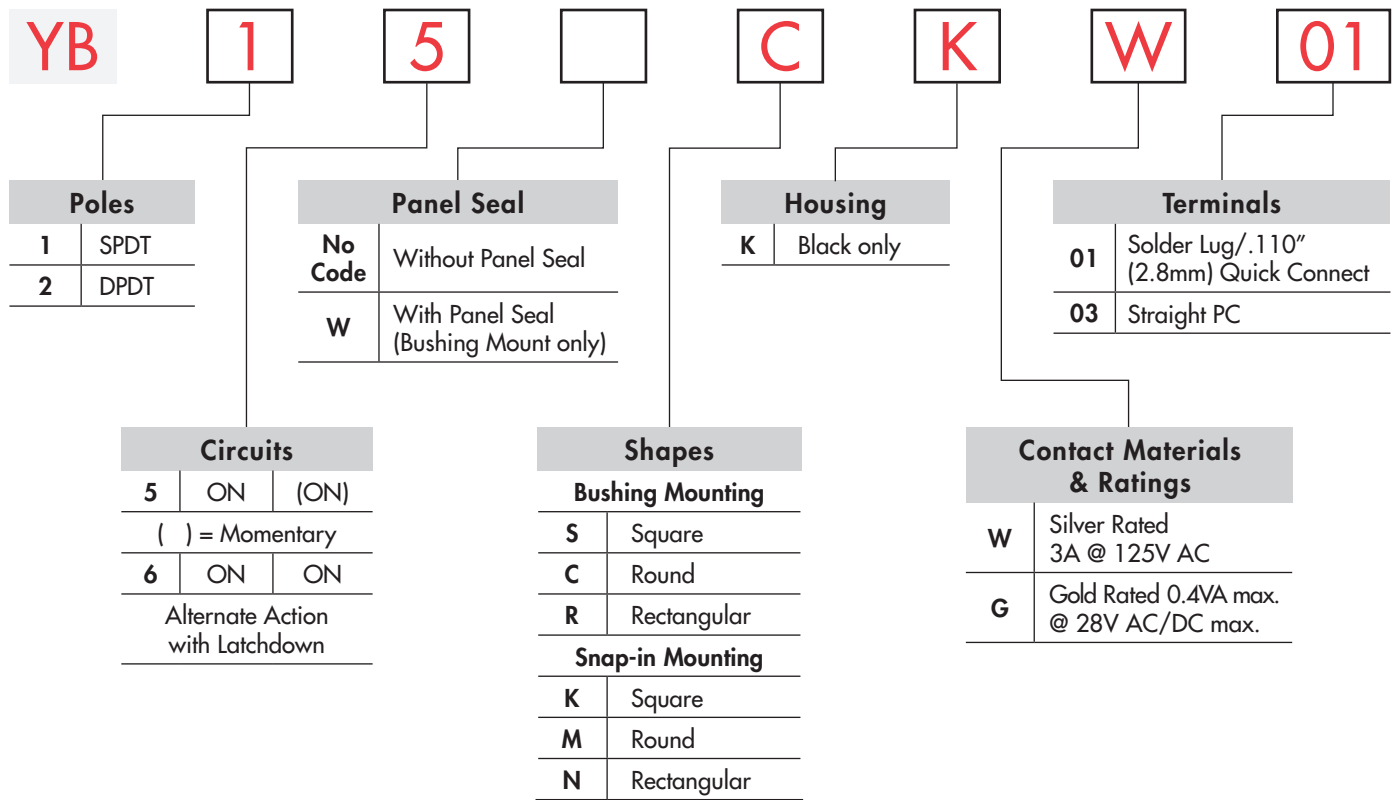

IMPORTANT:



Switches are supplied without UL & cULus marking unless specified.
UL & cULus recognized only when ordered with marking on switch.
 Specific models, ratings, & ordering instructions are noted on the General Specifications page.

DESCRIPTION FOR TYPICAL ORDERING EXAMPLE

YB15CKW01-6F-JB

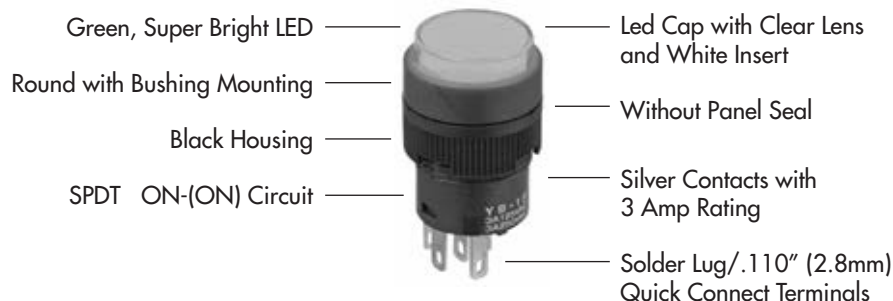

Toggles
Rocker
Pushbuttons
Illuminated PB
Programmable
Keylocks
Rotaries
Slides
Tactiles
Tilt
Touch
Indicators
Accessories
Supplement

ORDERING EXAMPLE

6 F

JB

Lamps

Incandescent Lamp

| | |
|----------------|----------------|
| 05 | 5-volt |
| 12 | 12-volt |
| No Code | Nonilluminated |

LED for Spot Illuminated Cap

| LED Colors | | Forward Voltage | |
|------------|-----------|-----------------|-------------------------|
| 1C | Red | 02 | 2-volt (no resistor) |
| 1D | Amber | | |
| 1F | Green | | |
| 1CF | Red/Green | 12 | 12-volt |
| | | 24 | 24-volt |

Bright LED

| LED Colors | | Resistor | |
|------------|-------|----------------|-------------|
| 5C | Red | No Code | No Resistor |
| 5D | Amber | 05 | 5-volt |
| | | 12 | 12-volt |
| 5F | Green | 24 | 24-volt |

Super Bright LED

| | |
|-----------|-------|
| 6B | White |
| 6F | Green |
| 6G | Blue |

Bicolor LED for Full Face Illuminated

| LED Colors | | Forward Voltage | |
|------------|-----------|-----------------|-------------------------|
| 2CF | Red/Green | 02 | 2-volt (no resistor) |
| | | 05 | 5-volt |
| | | 12 | 12-volt |
| | | 24 | 24-volt |

Cap Types & Colors

Solid Cap: Lens/Insert Colors

| | |
|-----------|--------------|
| BB | White/White |
| CB | Red/White |
| EB | Yellow/White |
| FB | Green/White |
| GB | Blue/White |

Spot Illuminated Cap: Lens/Insert Colors

| | |
|-----------|--------------|
| JA | Clear/Black |
| JB | Clear/White |
| JC | Clear/Red |
| JE | Clear/Yellow |
| JF | Clear/Green |

LED Cap: Lens/Insert Colors

| | |
|-----------|-------------|
| JB | Clear/White |
| JC | Clear/Red |
| JD | Clear/Amber |
| JF | Clear/Green |

LED Cap: Lens/Insert Colors

| | |
|-----------|-------------|
| JB | Clear/White |
|-----------|-------------|

LED Cap: Lens/Insert Colors

| | |
|-----------|-------------|
| JB | Clear/White |
|-----------|-------------|

Toggles
Rocker
Pushbuttons
Illuminated PB
Programmable
Keylocks
Rotaries
Slides
Tactiles
Tilt
Touch
Indicators
Accessories
Supplement

Toggles

Rockers

Pushbuttons

Illuminated PB

Programmable

Keylocks

Rotaries

Slides

Tactiles

Tilt

Touch

Indicators

Accessories

Supplement

POLES & CIRCUITS

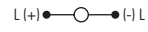
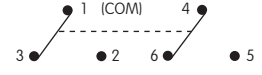
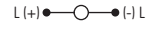
| Pole | Model | Plunger Position () = Momentary | | Connected Terminals | | Throw & Switch/Lamp Schematics |
|------|---------------|-------------------------------------|------------|---------------------|---------|--|
| | | Normal | Down | Normal | Down | |
| SP | YB15 *YB16 | ON ON | (ON) ON | 1-3 | 1-2 | Notes: Switch is marked with NC, NO, COM, L+, L-. Lamp circuit is isolated and requires external power source.   |
| DP | YB25 *YB26 | ON ON | (ON) ON | 1-3 4-6 | 1-2 4-5 |   |

* When in latchdown position for the alternate circuit, cap position is .020" (0.5mm) above the built-in bezel.

PANEL SEAL

No Code

Without Panel Seal

Bushing Mounting

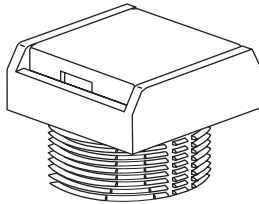

Supplied with mounting nut.

Snap-in Mounting

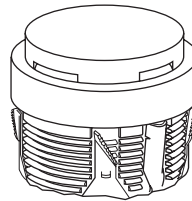

W

With Panel Seal

Bushing Mounting only

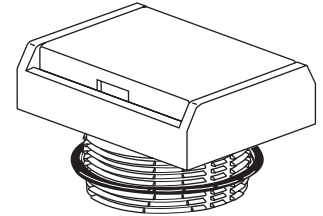

Supplied with mounting nut and o-ring AT089.

SHAPES & MOUNTING TYPES

Bushing Mounting

Snap-in Mounting

S

Square

C

Round

R

Rectangular

K

Square

M

Round

N

Rectangular

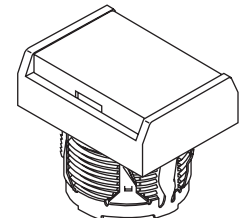
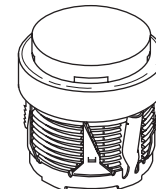
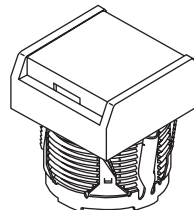
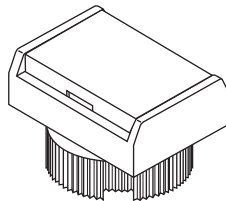
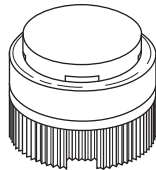
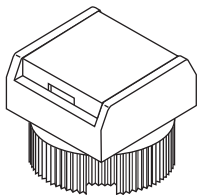

Bezel-barrier is an integral part of the switch body.

HOUSING

K

Black

Housing available in black only. The 1-piece body and bezel-barrier have a matte finish.

CONTACT MATERIALS & RATINGS

W

Silver Contacts

Power Level

3A @ 125/250V AC

G

Gold Contacts

Logic Level

0.4VA max. @ 28V AC/DC max.

Complete explanation of operating range in Supplement section.

TERMINALS

01 Solder Lug/
.110" (2.8mm) Quick Connect

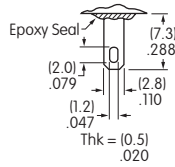

03 Straight PC

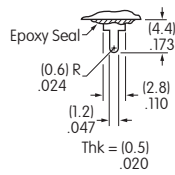

Single Pole

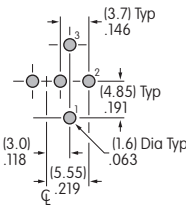

Double Pole

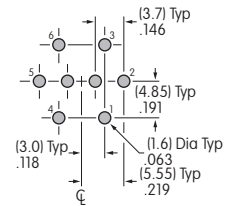

INCANDESCENT LAMP & SOLID CAP

Electrical specifications are determined at a basic temperature of 25°C. Lamp circuit is independent of switch operation. For dimension drawing of lamp see the Accessories & Hardware section.

| | | | | |
|--|---------------------------|-----------|---------------|--------|
| AT611  T-1 Bi-pin | | 05 | 12 | |
| | Voltage | V | 5V AC | 12V AC |
| | Current | I | 115mA | 60mA |
| | MSCP | | .150 | .150 |
| | Endurance | Hours | 7,000 average | |
| | Ambient Temperature Range | | -25°C ~ +50°C | |

No Code No Lamp

Solid Cap for Incandescent Lamp & Nonilluminated

Lens/Insert
Colors Available:

- BB** White/White
- CB** Red/White
- EB** Yellow/White
- FB** Green/White
- GB** Blue/White

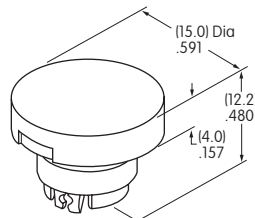

AT3002
Round

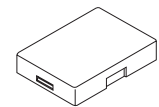

Translucent Colored Lens

AT3001
Square

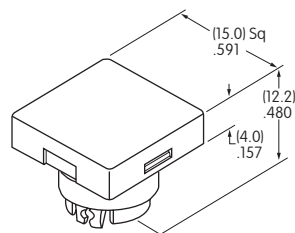

AT3003
Rectangular

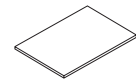
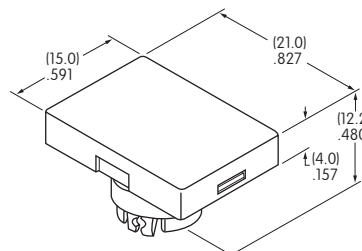

Translucent White Insert

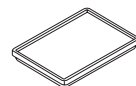

Translucent White Seal/Filter



Incandescent Lamp AT611

Materials:

Lens & Insert: Polycarbonate Seal/Filter: Thermoplastic Elastomer

SPOT ILLUMINATED CAP WITH BUILT-IN LED

This spot-illuminated cap is factory assembled.

AT3010
Square

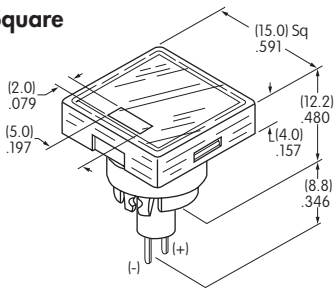

AT3011
Round

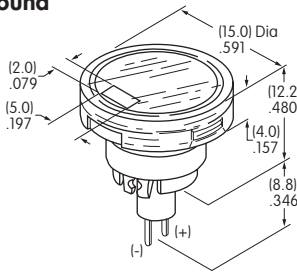

AT3012
Rectangular

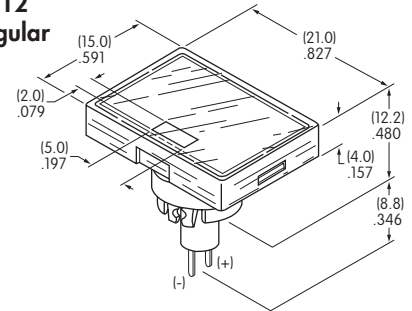

Colors Available:

| | | | |
|-----------|-----------|-----------|------------|
| 1C | 1D | 1F | 1CF |
| Red | Amber | Green | Red/Green |

| | | 02 Without Resistor Red or Amber | 02 Without Resistor Green or Red/Green | 05 With Resistor All Colors | 12 With Resistor All Colors | 24 With Resistor All Colors | Unit |
|--|--------------|--|--|--|--|--|-------|
| Maximum Forward Current | I_{FM} | 20 | 20 | 15 | 15 | 12 | mA |
| Typical Forward Current | I_F | 15 | 15 | 12.5 | 12.5 | 10 | mA |
| Forward Voltage | V_F | 1.9 | 2.1 | 5 | 12 | 24 | V |
| Maximum Reverse Voltage (not applicable to bicolor) | V_{RM} | 5 | 5 | 5 | 5 | 5 | V |
| Current Reduction Rate Above 25°C | ΔI_F | 0.27 | 0.27 | — | — | — | mA/°C |
| Ambient Temperature Range | | -25 ~ +50 | | | | | °C |

Without Resistor 2-volt

With Resistor 5, 12, 24-volt

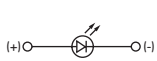

Single Color

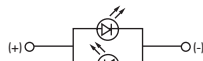

Bicolor

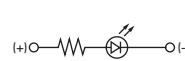

Single Color

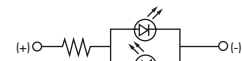

Bicolor

The electrical specifications shown are determined at a basic temperature of 25°C. LED circuit is isolated and requires external power source. Single color LEDs are colored in OFF state. Bicolor LED is translucent white in OFF state.

If the source voltage exceeds the rated voltage, a ballast resistor is required.
The resistor value can be calculated by using the formula in the Supplement section.

Lens/Insert
Colors Available:

| | |
|-----------|--------------|
| JA | Clear/Black |
| JB | Clear/White |
| JC | Clear/Red |
| JE | Clear/Yellow |
| JF | Clear/Green |



Clear Lens

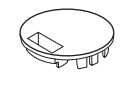

Colored Insert



Seal

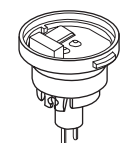

Built-in LED
(integral part
of the cap)

Example part number
when cap is ordered separate
from switch:

AT3010F02JA

for a
Square Spot Illuminated Cap
with Green 2-volt LED
without resistor
Clear Lens and Black Insert

Materials:

Lens & Insert: Polycarbonate
Seal: Thermoplastic Elastomer

BRIGHT LED & LED CAPS

The electrical specifications shown are determined at a basic temperature of 25°C.
 LED circuit is isolated and requires external power source.
 If the source voltage exceeds the rated voltage, a ballast resistor is required.
 The resistor value can be calculated by using the formula in the Supplement section.

Electrical Specifications for Bright LED without Resistor

| | | | | | | |
|---|--|--------------|-----------|-------|-----|-------|
| Bright AT628   T-1 Bi-pin | Colors Available: 5C Red 5D Amber 5F Green No Code No Resistor | Unit | | | | |
| | LED Colors | Red | Amber | Green | | |
| | Maximum Forward Current | I_{FM} | 40 | 40 | 40 | mA |
| | Typical Forward Current | I_F | 26 | 26 | 26 | mA |
| | Forward Voltage | V_F | 1.9 | 2.0 | 2.0 | V |
| | Maximum Reverse Voltage | V_{RM} | 4 | 4 | 4 | V |
| | Current Reduction Rate Above 25°C | ΔI_F | 0.50 | | | mA/°C |
| | Ambient Temperature Range | | -25 ~ +50 | | | °C |

Electrical Specifications for Bright LED with Resistor

| | | | | | | |
|--|---|--------------|-----------|----|----|-------|
| Bright AT634  T-1 1/4 Bi-pin | Colors Available: 5C Red 5D Amber 5F Green 05 12 24 | Unit | | | | |
| | Maximum Forward Current | I_{FM} | — | — | — | mA |
| | Typical Forward Current | I_F | 25 | 20 | 10 | mA |
| | Forward Voltage | V_F | 5 | 12 | 24 | V |
| | Maximum Reverse Voltage | V_{RM} | 4 | 8 | 16 | V |
| | Current Reduction Rate Above 25°C | ΔI_F | — | — | — | mA/°C |
| | Ambient Temperature Range | | -25 ~ +50 | | | °C |

AT634
5-volt,
2-element
with Resistor

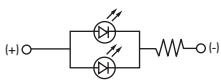

AT634
12-volt,
4-element
with Resistor

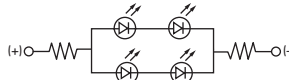

AT634
24-volt,
4-element
with Resistor

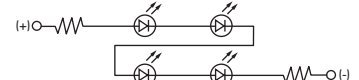

Cap for Bright LED

Lens/Insert
Colors Available:

- JB Clear/White
- JC Clear/Red
- JD Clear/Amber
- JF Clear/Green

AT3004
Square

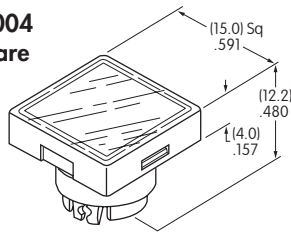

AT3005
Round

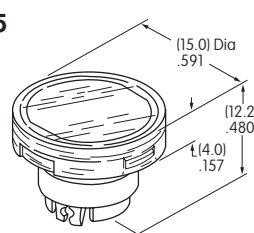

AT3006
Rectangular

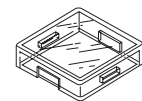
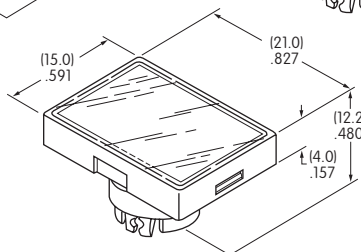

Transparent Clear Lens

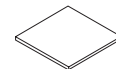

Translucent Colored Insert

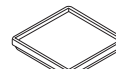

Translucent White Seal/Diffuser



Bright LEDs
AT628 AT634



Materials:

Lens & Insert: Polycarbonate Seal/Diffuser: Thermoplastic Elastomer

SUPER BRIGHT LED & LED CAPS

The electrical specifications shown are determined at a basic temperature of 25°C.
 LED circuit is isolated and requires external power source.
 If the source voltage exceeds the rated voltage, a ballast resistor is required.
 The resistor value can be calculated by using the formula in the Supplement section.

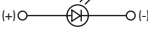
Electrical Specifications for Super Bright LED

| Super Bright AT625G Blue AT631B White AT632F Green |  |  | 6B | 6F | 6G | Unit |
|---|---|---|---------|-----------|-------|-------|
| | | | Colors: | White | Green | |
|  T-1 Bi-pin | Maximum Forward Current | I_{FM} | 30 | 30 | 30 | mA |
| | Typical Forward Current | I_F | 20 | 20 | 20 | mA |
| | Forward Voltage | V_F | 3.3 | 3.3 | 3.3 | V |
| | Maximum Reverse Voltage | V_{RM} | 7 | 7 | 7 | V |
| | Current Reduction Rate Above 25°C | ΔI_F | 0.40 | 0.40 | 0.40 | mA/°C |
| | Ambient Temperature Range | | | -25 ~ +50 | | °C |

Cap for Super Bright LED

AT3014
Square

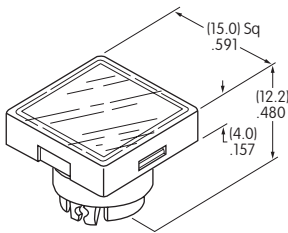

AT3015
Round

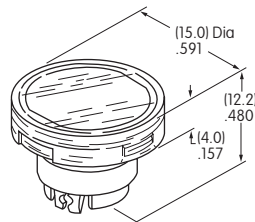

AT3016
Rectangular

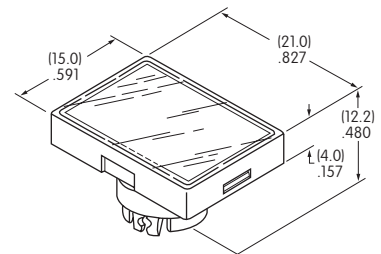

Lens/Insert
Colors Available:

JB Clear/White

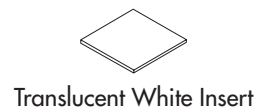

Super Bright LEDs
AT625 AT631
AT632

Materials:
 Lens & Insert: Polycarbonate Seal/Diffuser: Thermoplastic Elastomer

BICOLOR LED & LED CAPS

The electrical specifications shown are determined at a basic temperature of 25°C.
 LED circuit is isolated and requires external power source.
 If the source voltage exceeds the rated voltage, a ballast resistor is required.
 The resistor value can be calculated by using the formula in the Supplement section.

Electrical Specifications for Bicolor LED

| | | | | | | | |
|---|--|--------------|-----------|-----------|-----------|------|-------|
| Bicolor AT621 2CF Red/Green  T-1 1/2 Bi-pin | Bicolor LED is translucent white in OFF state. | 02 | 05 | 12 | 24 | Unit | |
| | Maximum Forward Current | I_{FM} | 60 | 60 | 20 | 12 | mA |
| | Typical Forward Current | I_F | 45 | 45 | 15 | 10 | mA |
| | Forward Voltage (Red/Green) | V_F | 1.9 / 2.1 | 5 | 12 | 24 | V |
| | Current Reduction Rate Above 25°C | ΔI_F | 0.80 | — | — | — | mA/°C |
| | Ambient Temperature Range | | -25 ~ +50 | | | | °C |

AT621
 Bicolor LED
 2-volt
 6-element
 without Resistor

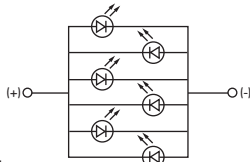

AT621
 Bicolor LED
 5-volt
 6-element
 with Resistor

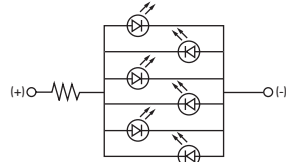

AT621
 Bicolor LED
 12 & 24-volt
 6-element
 with Resistor

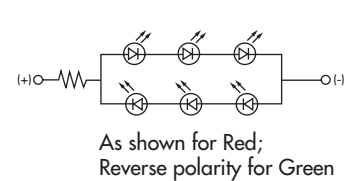

LED Caps

AT3004
 Square

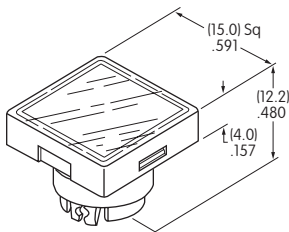

AT3005
 Round



AT3006
 Rectangular

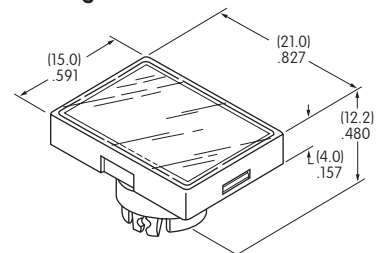

Lens/Insert
 Colors Available:

JB Clear/White

Transparent Clear Lens

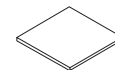

Transparent White Insert



Translucent White Seal/Diffuser



Materials:

Lens & Insert: Polycarbonate Seal/Diffuser: Thermoplastic Elastomer

Bicolor LED AT621

TYPICAL SWITCH DIMENSIONS

Square • Bushing Mounting

Single & Double Pole

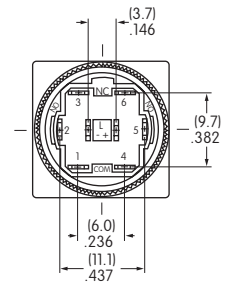
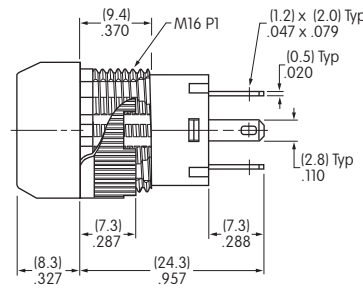
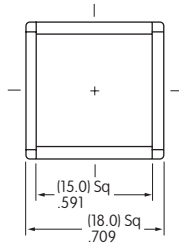

YB15SKW01-12-CB

Single pole models do not have terminals 4, 5, & 6.

Round • Panel Seal

Single & Double Pole

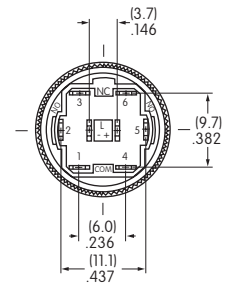
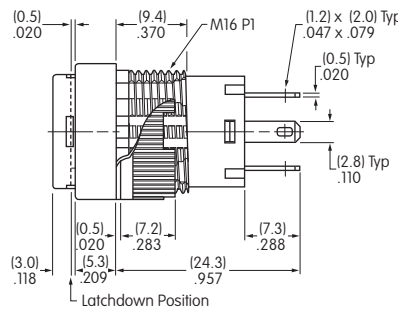
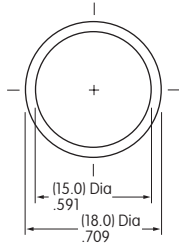

YB26WCKW01-12-EB

Single pole models do not have terminals 4, 5, & 6.

Rectangular • Snap-in Mounting

Single & Double Pole

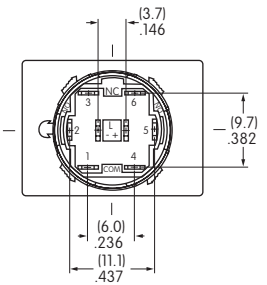
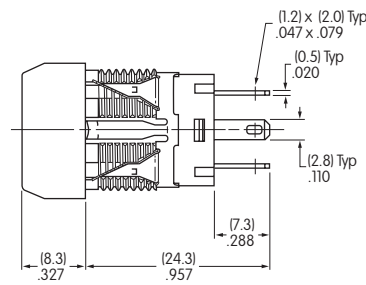
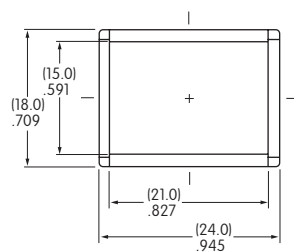

YB15NKW01-5C-JC

Single pole models do not have terminals 4, 5, & 6.

PANEL THICKNESS & CUTOUTS

Bushing & Panel Seal Mount

Panel Thickness
.020" ~ .197"
(0.5mm ~ 5.0mm)

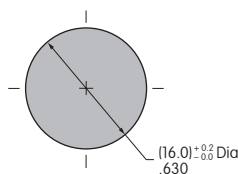

Snap-in Mount

Panel Thickness
.039" ~ .138"
(1.0mm ~ 3.5mm)

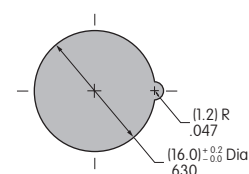

OPTIONAL ACCESSORIES

Dust Covers and Protective Guards reduce depth of switch behind panel by .047" (1.2mm).

Panel Thickness Range with Dust Cover or Protective Guards:

Bushing Mounting
.020" ~ .150" (0.5mm ~ 3.8mm)

Snap-in Mounting
.020" ~ .091" (0.5mm ~ 2.3mm)

Panel Seal
.020" ~ .118" (0.5mm ~ 3.0mm)

AT4115 Dust Cover for Snap-in or Bushing Mount



Dust/Splash Cover

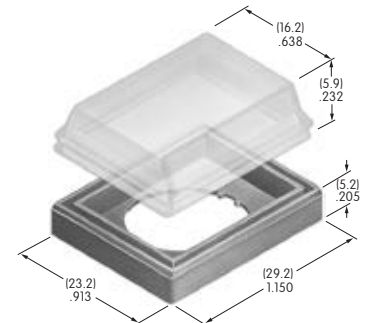
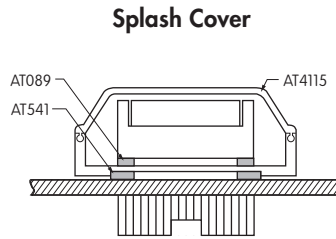

AT4115 Splash Cover and AT541 O-ring for Bushing Mount

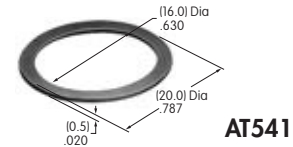

Materials:
Lid: Polyvinyl Chloride
Base: Polyamide
O-ring: Nitrile butadiene rubber

Snap-in Mount

Panel Seal

Note: AT089 o-ring supplied with panel seal model.

AT4072 Protective Guard

Opens 90°
Closes manually



Protective Guard

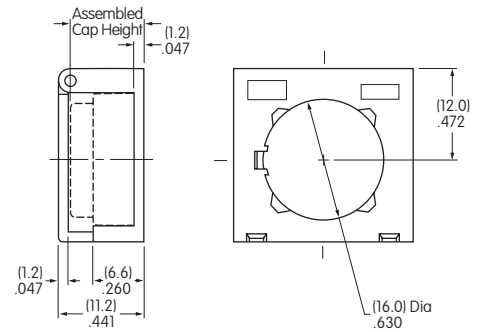
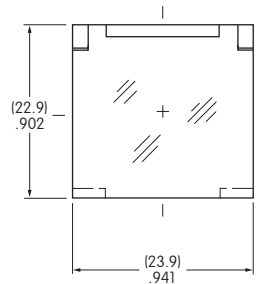

Materials:
Lid: Polycarbonate
Base: Glass Fiber Reinforced Polycarbonate

AT4175 Spring Loaded Protective Guard

Opens 180°
Closes automatically



Spring Loaded Protective Guard

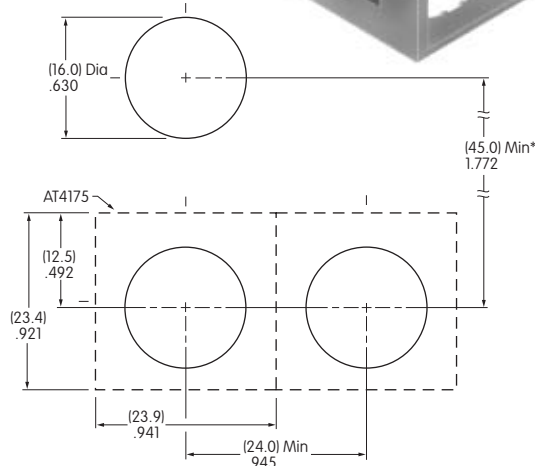
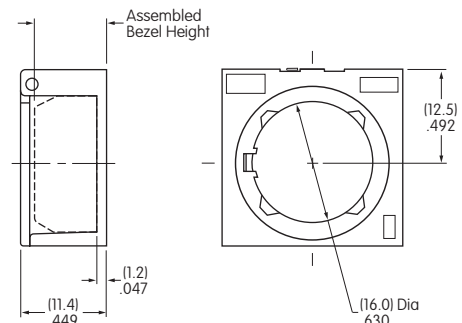
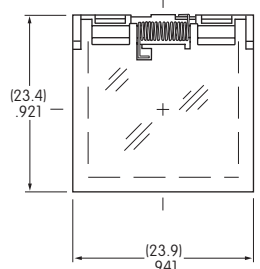

Materials:
Lid: Polycarbonate
Base: Glass Fiber Reinforced Polyamide
Coil Spring: Stainless Steel

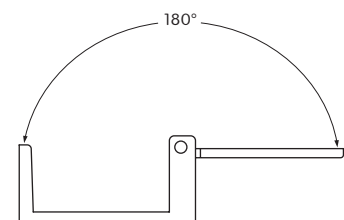

* Minimum dimension allows opening of cover to 180°

OPTIONAL ACCESSORIES

Adaptors

AT716
Single Pole
Solder Lug/
Quick Connect
Terminals

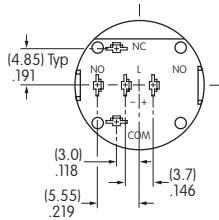
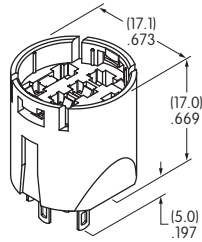

AT717
Double Pole
Solder Lug/
Quick Connect
Terminals

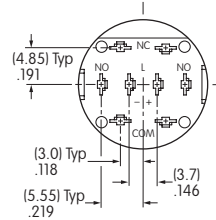
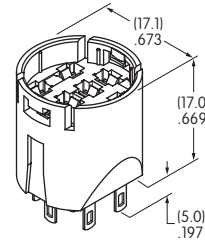

AT718
Single Pole
Straight PC
Terminals

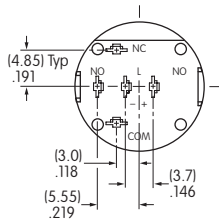

AT719
Double Pole
Straight PC
Terminals

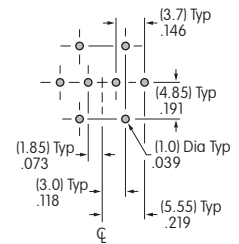
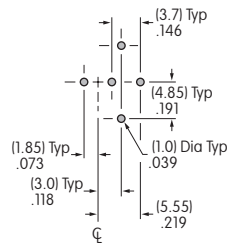
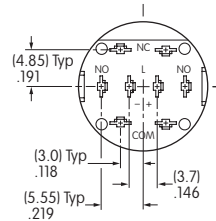
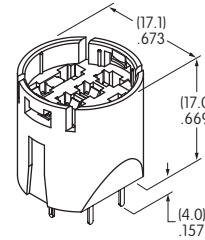

Material: Glass fiber reinforced polyamide Note: Order adaptors separately

Switch Dimensions Shown with Adaptor AT716

Dimension A:
Solder Lug .197" (5.0mm); Straight PC .157" (4.0mm)

Panel thickness for YB Bushing Mount:
.020" ~ .197" (0.5mm ~ 5.0mm)

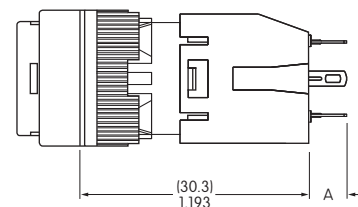

Toggles
Rockers
Pushbuttons
Illuminated PB
Programmable
Keylocks
Rotaries
Slides
Tactiles
Tilt
Touch
Indicators
Accessories
Supplement

ASSEMBLY INSTRUCTIONS

Cap Assembly

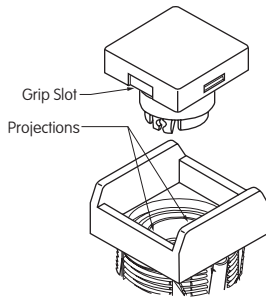

LED Polarity & Orientation in Lamp Socket

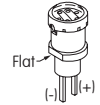
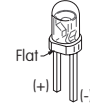
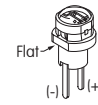
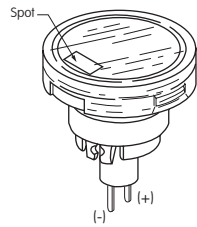
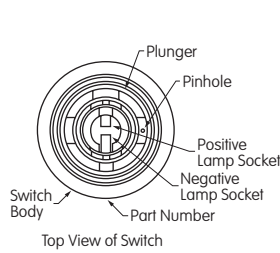

Spot Illuminated Cap with Built-in LED

LED AT628 AT634

LEDs AT625G AT631B AT632F

LED AT621

The following installation tools are available: AT106 Socket Wrench for bushing mounting (Overtightening the mounting nut AT092 may damage the switch housing.); AT109 Cap Extractor; AT111 Lamping Tool. Further details and dimensions are shown in the Accessories and Hardware section.

LEGENDS

NKK Switches can provide custom legends for caps. Contact factory for more information.

Suggested Printable Area for YB Lens

Recommended Methods: Laser Etch on clear lens, Screen Print or Pad Print on Lens. Epoxy based ink is recommended.

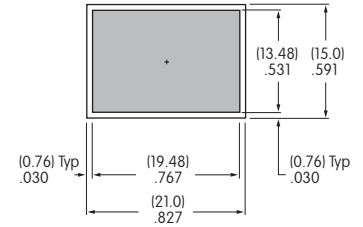
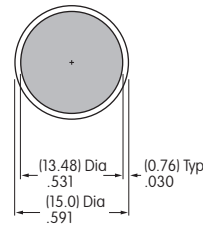
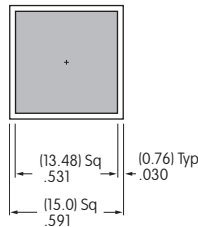

Shaded areas are printable areas.

Suggested Printable Area for Film Insert

Recommended Print Method: Laser Print
 Film Insert: Clear Polyester, 4 mil max. thickness

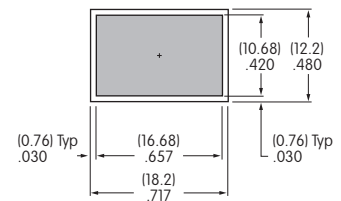
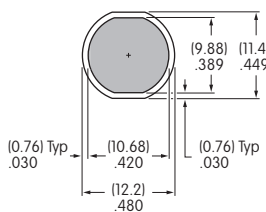
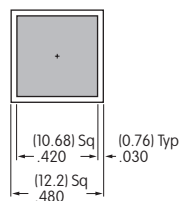
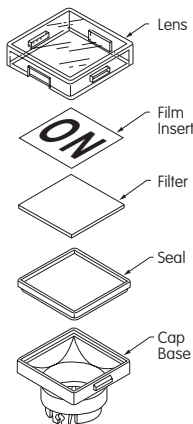

Shaded areas are printable areas.

Toggles
 Rockers
 Pushbuttons
D Illuminated PB
 Programmable
 Keylocks
 Rotaries
 Slides
 Tactiles
 Tilt
 Touch
 Indicators
 Accessories
 Supplement